

wood expressions blinds

fittings

Check you've got all the fittings that come with your wood expressions blind

- 1 End brackets: 1 pair

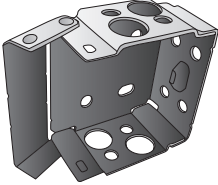

- 2 Matching fascia and fascia clips

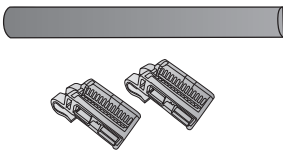

- 3 Matching end returns and corner clips (if blind is to be fitted outside the window recess)

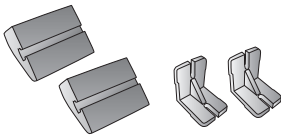

- 4 Centre support bracket (if length requires)

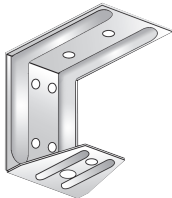

- 5 Screws: min 4

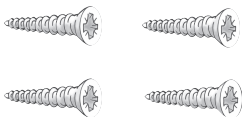

- 6 Rawl plugs: min 4

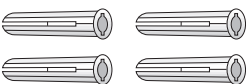

- 7 Blind: 1

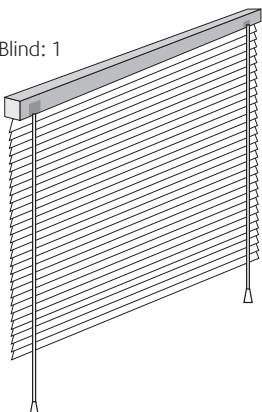

fitting instructions

Before you start, check you have your brackets

Your blind brackets are packed separately at the end of the box. Check you've taken them out before you throw the packaging away.

You can fit your wood expressions blind in 3 straightforward stages. Just do these in order and you'll soon have your new blind up.

1. Fit the headrail 2. Attach the blind 3. Fit the valance

1. fit the headrail

fitting your blind outside the window (exact fitting)

To make sure the centre of the rail is precisely in the middle of your window, the measurements at either end (C) need to be the same. To work out C:

- measure the width of the window (measurement B). Write down the measurement.
- measure the width of the blind (measurement A). Write down the measurement.

Take measurement B away from measurement A and divide the answer by 2 to get measurement C.

Now follow the instructions for **face fixing**.

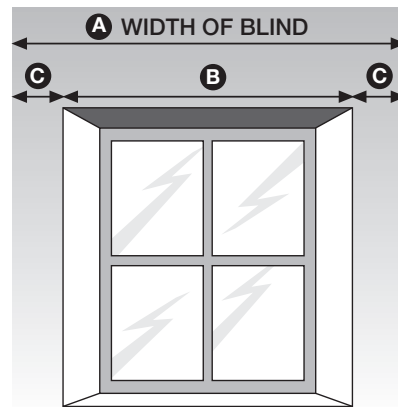

TOP FIX FACE FIX

fitting your blind inside the window (recess fitting)

You need to decide whether to **face fix or top fix your blind**.

Top fix your blind to the lintel if:

- you have uPVC window frames, or
- there are obstructions like handles

Face fix your blind if:

- you want to fit the bracket to the window frame

Extend the door hinge on each bracket as far as it will go.

Brackets can be used on either the left or right, and the door is hinged on the side.

Put the bracket in place and mark 2 holes according to the type of fixing you've chosen (see step 1).

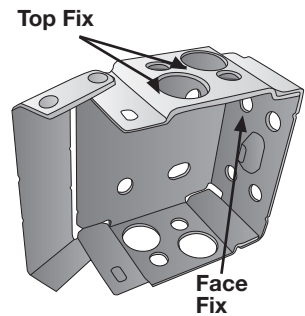

step two

2. attach the blind

Once you've fitted the brackets take the plastic end caps off the blind headrail. Slide the blind into the brackets.



step one

To lock the headrail into position, push down and snap shut the hinge doors.

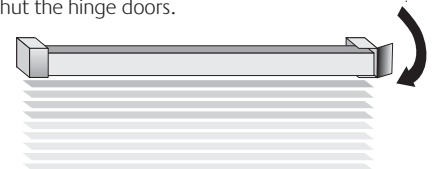

step two

continued overleaf

step one

wood expressions blinds

3. fitting the valance

Clip the plastic valance hooks to the top of the headrail, as shown.

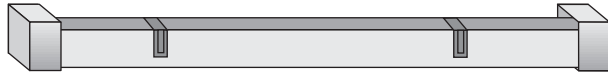

Fit the valance clips into the valance groove and turn to secure, as shown.



Push the valance clip into the valance hook, to fit the valance to the blind.

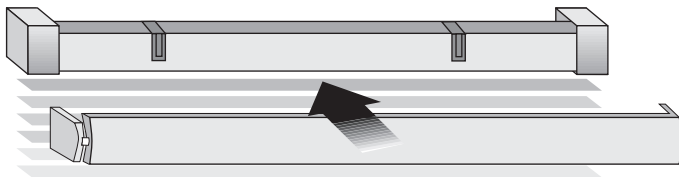

If your blind has returns (these are fascias that sit at the side of the blind and only come with blinds to be hung outside the window), fit as follows.

Returns

Valance ends (supplied if the blind is to be fitted outside of the recess)

Attach the valance end using the clip provided, as shown

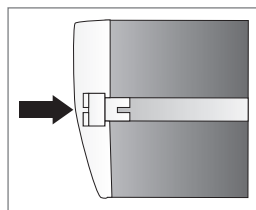

step one

To raise and lower the blind, use the cord on the right hand side. To lock the blind into position, pull the cord forward. Use the other cord to angle the slats.

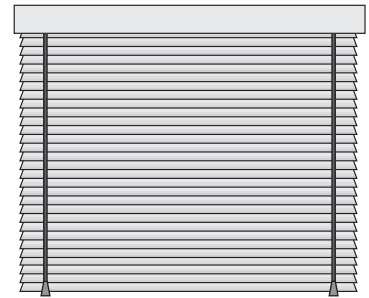

step two

Operating your blind is easy. Just follow these instructions.

- One cord controls the height of the wood expressions blind, the other controls the angle of the slats.
- To raise the blind, pull the cord down until the blind is at the height you want.
- To lower the blind, release the cord lock by pulling the cord across the front of the blind and let the cord slide through your fingers.
- Slats should be open when raising or lowering the blind.

WARNING

IN THE INTEREST OF SAFETY, IT IS ADVISABLE TO KEEP ALL PULL CORDS AND CHAIN/BEAD CORDS OUT OF THE REACH OF CHILDREN.